

INDUSTRY 4.0
AND IoT READY



PLASTIC DIVISION



COMERIO ERCOLE

QUALITY & TECHNOLOGY SINCE 1885 ITALY



THE ORIGIN, THE PRESENT, THE FUTURE IN ADVANCED TECHNOLOGY

COMERIO ERCOLE is a company operating since more than one hundred years at world-wide level, which does not limit its portfolio to machines and plants only, but which is able to provide 360° integrated services like engineering and know-how at all levels, and shared R&D projects promoting international industrial co-operation. **COMERIO ERCOLE** grants a wide and qualified technical assistance all over the world stocking in our warehouses of the main spare parts and special components for all production range and providing a wide net of co-operators and high qualified technicians ready to be present all over the world.

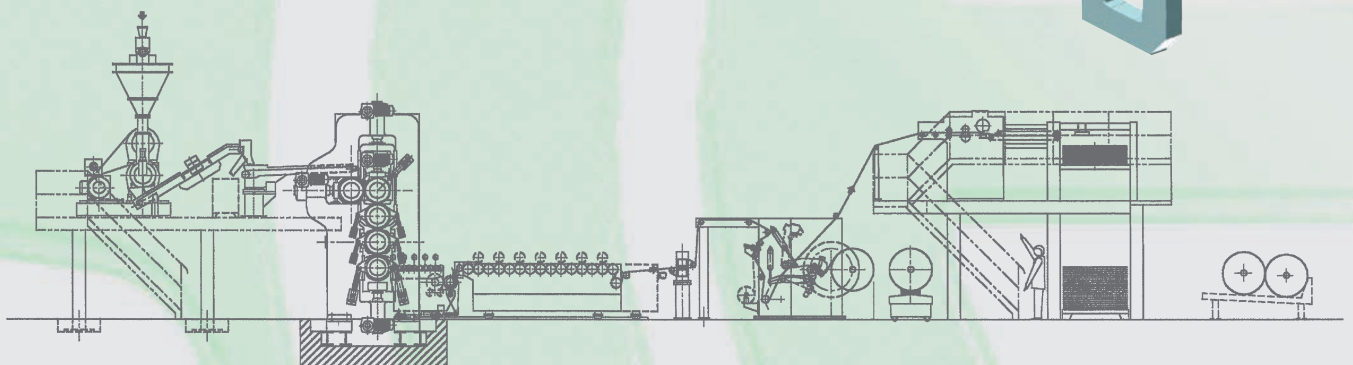

PRODUCTION PROGRAM

- Patented mixing mills and mixer
- Strainer and compounding extruder
- Handling, weighing and dosing systems
- Hot and cold mixer
- Laboratory
- 2, 3, 4 and 5 roll calenders with L, F configuration
- Complete calendaring lines for rigid, semi-rigid and soft PVC
- Calendaring lines CEMA for PVC, PU, CPE and PP
- Complete calendaring lines for Polyolefines
- Automatic wind-up units
- Transversal stretching units
- Revamping of existing lines
- Lamination and embossing units
- Turn key projects

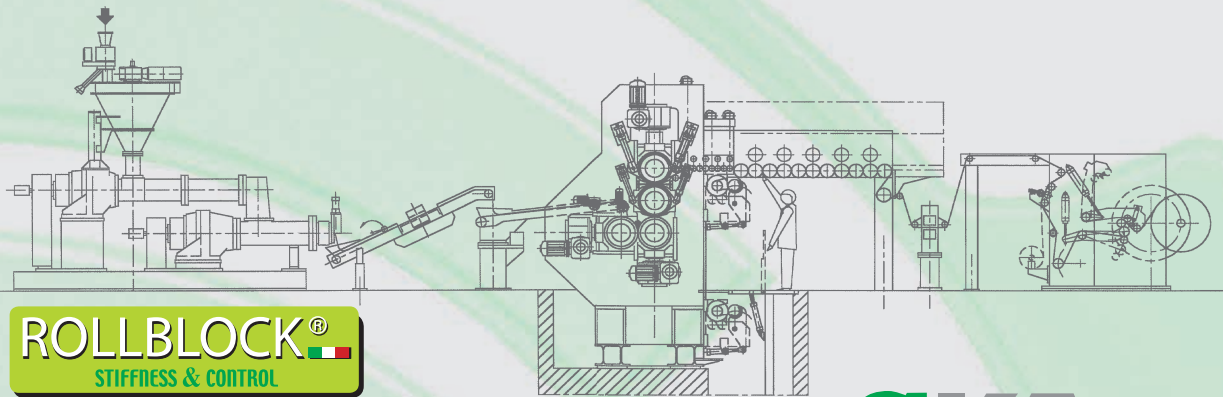
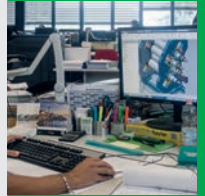
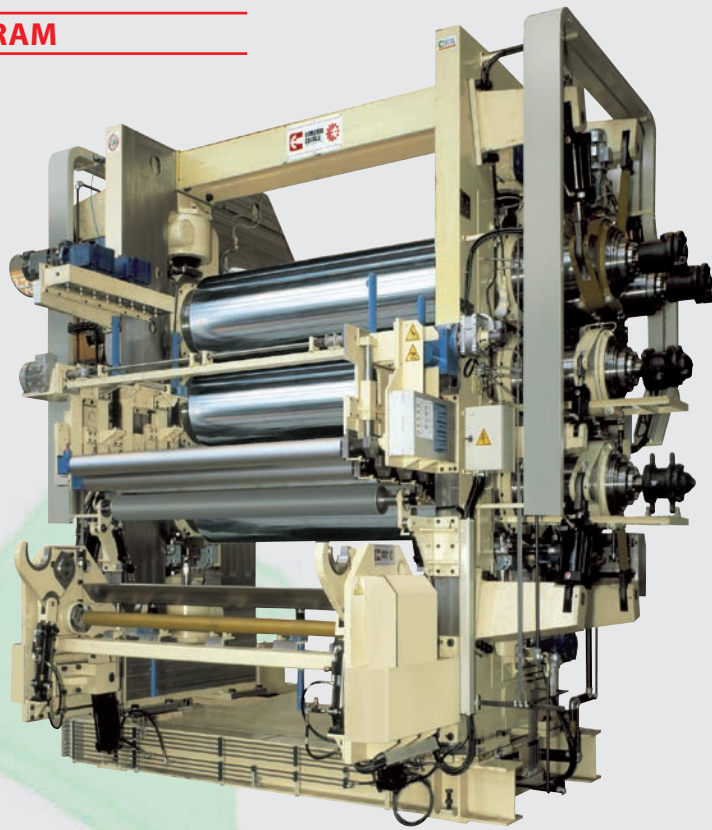

ROLLBLOCK®
STIFFNESS & CONTROL

HYDROGAP®
SPEED & PRECISION

HYDROTHERM®
THERMAL EXPANSION CORRECTION

CKA

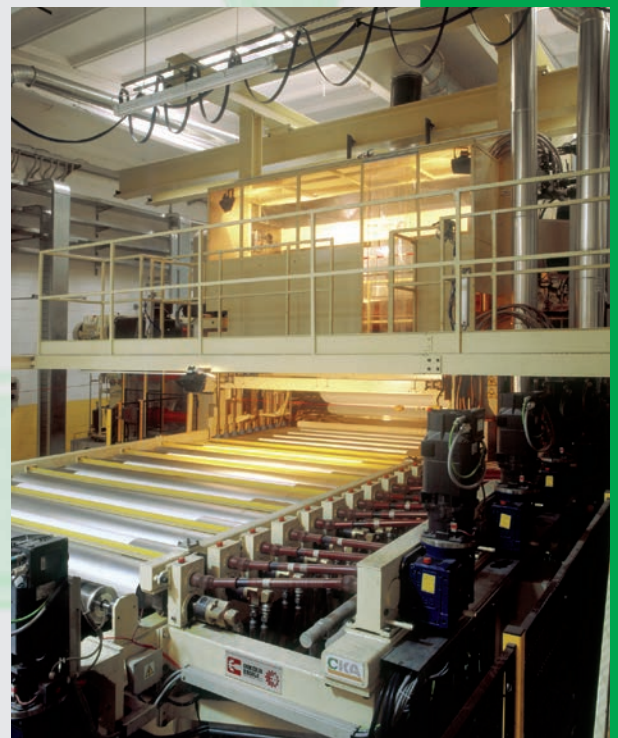
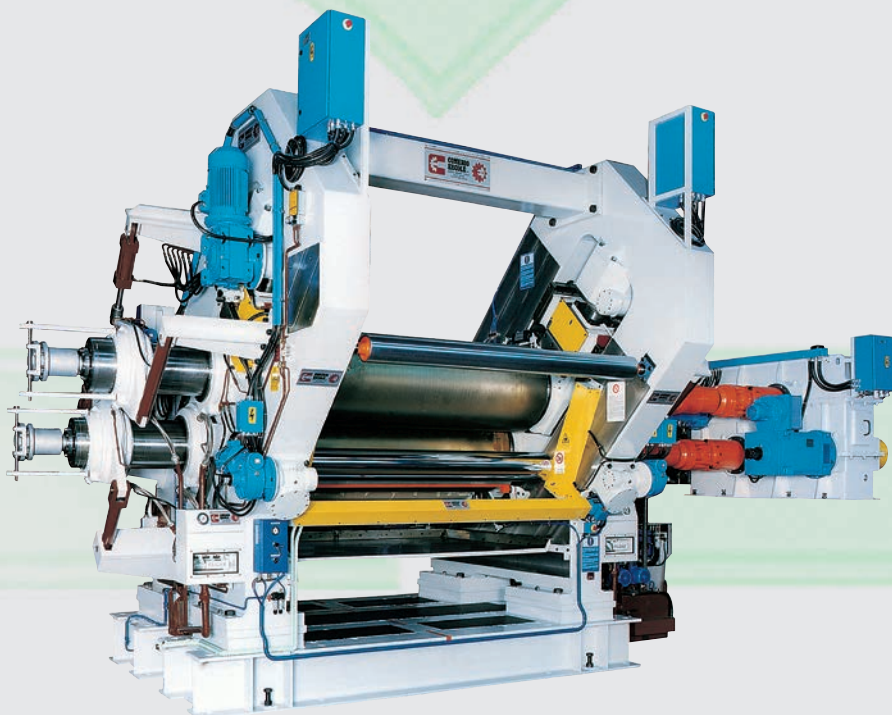



PRODUCTION PROGRAMM



ENGINEERING

Engineering services
Know how provider
Laboratory service
Turn key special projects & Products



RUBBER

Calendering & Mixing Technology
Rubber production machines and plants
Vulcanizing rotary machines
Hydraulic presses
Tires & Conveyor belts production process plant



PLASTIC

Calendering, Extrusion & Stretching Technology
Special lamination and embossing machines
Plastic production machines & plants



NONWOVENS

Thermal bonding calender technology
Embossing/gauging and laminating technology
Spunbonding & Air-laid technology
Nonwovens production machines & plants

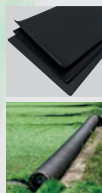

RECYCLING

Tire recycling system to obtain secondary raw materials in various extrusion
Special patented Extrusion technology
ETP plant from wasted tires rubber crumbs



SPECIAL PRODUCTS

R&D projects & tailored products
Gaskets calendering technology
Special adhesive tapes calendering technology
Textile Finishing technology: padders & calenders
Stainless steel & Paper embossing technology

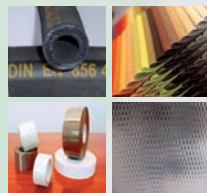

REPOWER

Safety assessment
Compliance report
Refurbishment
Renovation
Revision
Industry 4.0 Update



CUSTOMER SERVICE

Technical assistance & Teleservice
Original spare parts
Refurbishment & Safeties updating
Training & Technological assistance
Installation & Commissioning



PLASTIC DIVISION



**Choose the Original
Choose Success!**



www.comercole.it



COMERIO ERCOLE

QUALITY & TECHNOLOGY SINCE 1885 ITALY



21052 BUSTO ARSIZIO (VA) ITALY - Via Castellanza, 100
Tel. +39.0331.488411 - Fax +39.0331.488421
Customer Service Fax +39.0331.488513

Internet: <http://www.comercole.it> E-mail: info@comercole.it