

PLASTIC DIVISION



COMERIO ERCOLE

QUALITY & TECHNOLOGY SINCE 1885 ITALY



MARKING
FORICO

THE ORIGIN, THE PRESENT, THE FUTURE IN ADVANCED TECHNOLOGY

COMERIO ERCOLE has been operating worldwide for more than one hundred thirty years. Its portfolio is not only limited to the supply of machines and plants, but is able to provide 360° integrated services like engineering and know-how at all levels and shared R&D projects promoting the international industrial cooperation. **COMERIO ERCOLE** grants a wide and qualified technical assistance all over the world stocking in its warehouse spare parts and special components or all production range; by providing a wide net of co-operators and high qualified technicians ready to intervene all over the world.

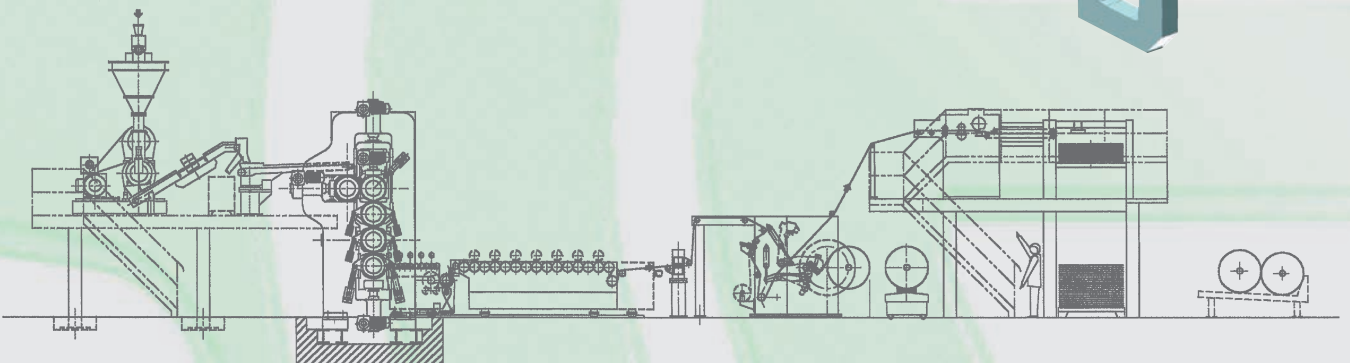

PRODUCTION PROGRAM

- Patented mixing mills and mixer
- Strainer and compounding extruder
- Handling, weighing and dosing systems
- Hot and cold mixer
- Laboratory
- 2, 3, 4 and 5 roll calenders with L, F configuration
- Complete calendaring lines for rigid, semi-rigid and soft PVC
- Calendaring lines CEMA for PVC, PU, CPE and PP
- Complete calendaring lines for Polyolefines
- Automatic wind-up units
- Transversal stretching units
- Revamping of existing lines
- Lamination and embossing units
- Turn key projects

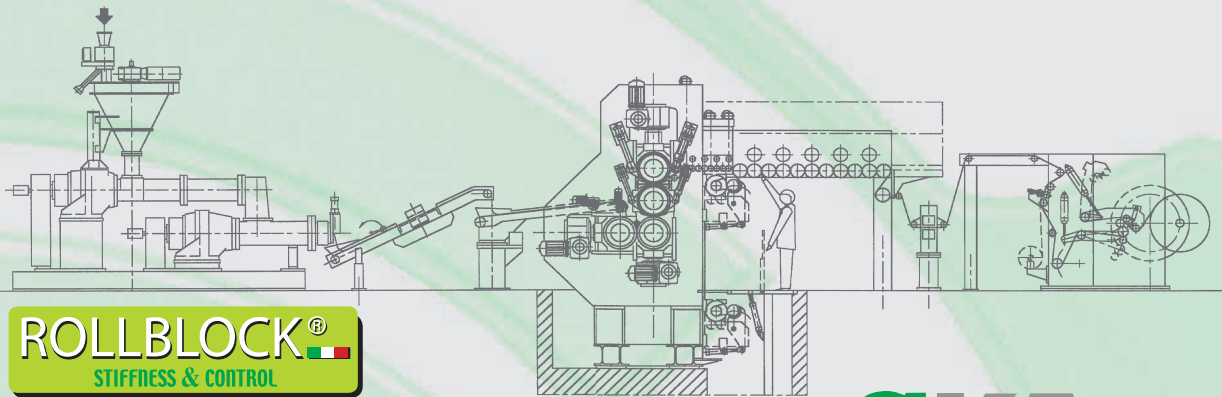
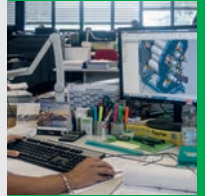
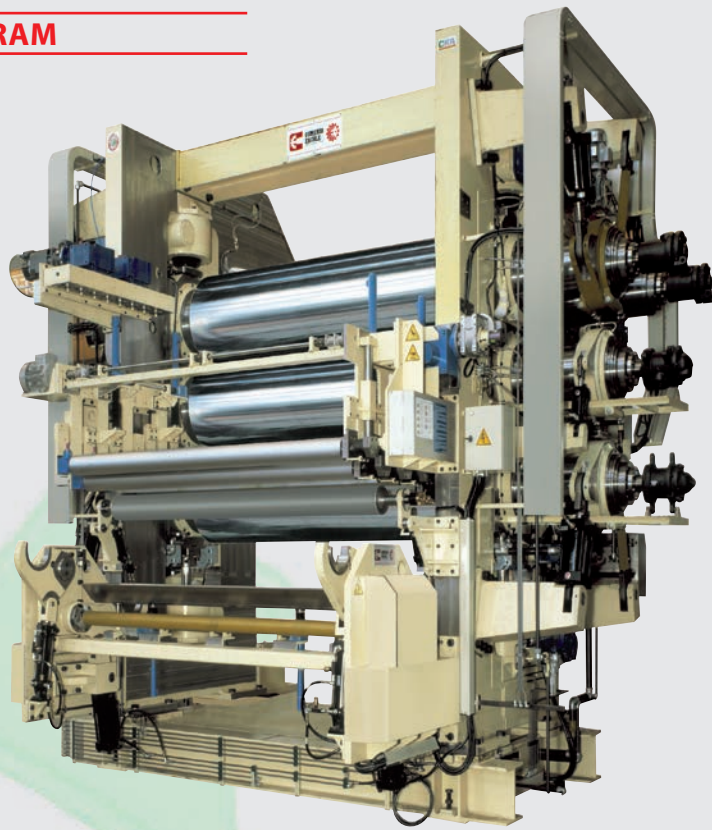

ROLLBLOCK®
STIFFNESS & CONTROL

HYDROGAP®
SPEED & PRECISION

HYDROTHERM®
THERMAL EXPANSION CORRECTION

CKA

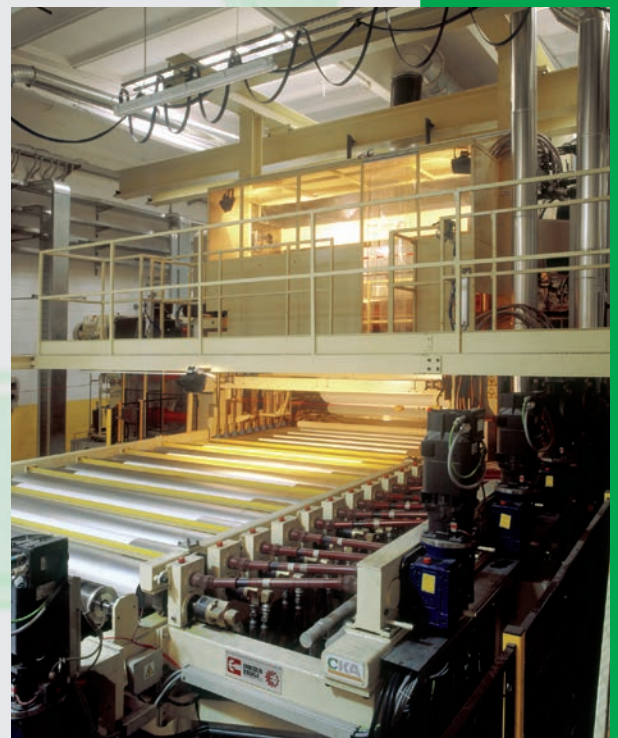

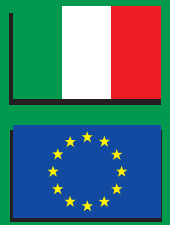
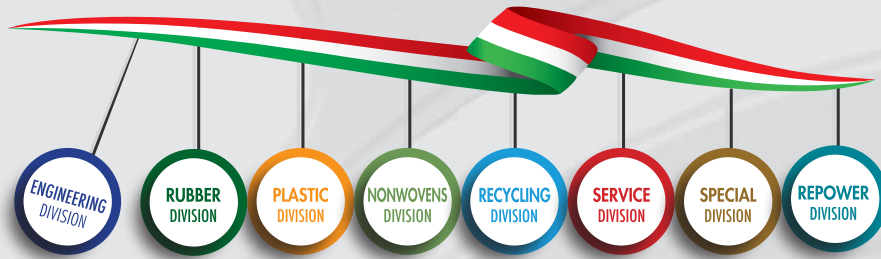

PRODUCTION PROGRAMM



ENGINEERING

Engineering services
Know how provider
Laboratory service
Turn key special projects & Products

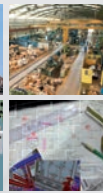

RUBBER

Calendering & Mixing Technology
Rubber production machines and plants
Vulcanizing rotary machines
Hydraulic presses
Tires & Conveyor belts production process plant



PLASTIC

Calendering, Extrusion & Stretching Technology
Special lamination and embossing machines
Plastic production machines & plants



NONWOVENS

Thermal bonding calender technology
Embossing/gauging and laminating technology
Spunbonding & Air-laid technology
Nonwovens production machines & plants

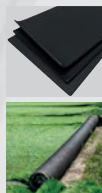

RECYCLING

Tire recycling system to obtain secondary raw materials in various extrusion
Special patented Extrusion technology
ETP plant from wasted tires rubber crumbs



SPECIAL PRODUCTS

R&D projects & tailored products
Gaskets calendering technology
Special adhesive tapes calendering technology
Textile Finishing technology: padders & calenders
Stainless steel & Paper embossing technology



REPOWER

Safety assessment
Compliance report
Refurbishment
Renovation
Reversion
Industry 4.0 Update

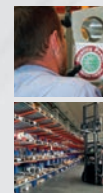

CUSTOMER SERVICE

Technical assistance & Teleservice
Original spare parts
Refurbishment & Safeties updating
Training & Technological assistance
Installation & Commissioning



PLASTIC DIVISION



www.comercole.it

COMERIO1885
HOLDING *Società Benefit*



COMERIO ERCOLE
QUALITY & TECHNOLOGY SINCE 1885 ITALY



21052 BUSTO ARSIZIO (VA) ITALY - Via Castellanza, 100
Tel. +39.0331.488411 - Fax. +39.0331.488421
<http://www.comercole.it> • E-mail: info@comercole.it

